



Models

6202 | 6303 | 6302 | 6302U | 6210

Sonesta Gynecology & Urology Procedure Chairs



Sonesta Medical offers the following accessories for its Sonesta products (excluding model 6210). Standard colors are #12 (Blue) in Europe/Asia or #2 (Grey) in USA.

Accessories

A = Available

524-6316
IV pole

An IV pole with holder that attaches to a support under the seat cushion. The IV pole will stay in the height relative to the patient as it moves as the table is adjusted. To be mounted on patients right side of the chair.

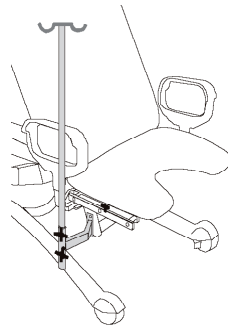

6202	6303	6302	6302U
A	A	A	A

~~524-6319 Discontinued article~~

~~Swingarm MFD Flow transducer~~

~~Type MFD - Made to hold the uroflow unit made by MFD, this unit moves up and down with the table and can be easily swung out of the way when not in use. To be mounted on patients right side of the chair.~~

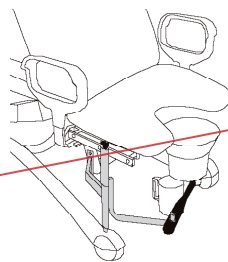

6202	6303	6302	6302U
A	A	A	A

524-6325-1
Drainage Receptacle

Standard receptacle 60mm deep - A stainless steel receptacle with an adjustable 'quick change' holder.

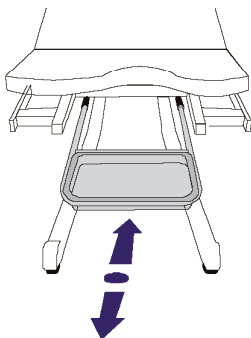

6202	6303	6302	6302U
A	A	A	A

524-6325-5
Plastic Funnel

A removable plastic funnel (236mm diameter top) mounted on a fixed height 'quick change' holder.

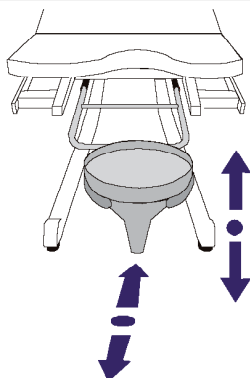

6202	6303	6302	6302U
A	A	A	A

524-6325-10
Funnel and cysto pan (US model only).

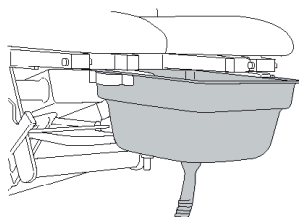

6202	6303	6302	6302U
A	A	A	A

524-6326
Paper Roll Holder

Adjustable width 400 mm - 600 mm - mounted on the top of the back of the back rest cushion.

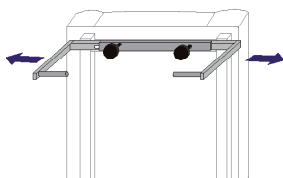

6202	6303	6302	6302U
A	A	A	A

525-6331
Fold Up Footrests (pair)

These footrests are adjustable in length from 30cm - 42cm. They are also adjustable in width and slide outward 19cm each. The bottom is upholstered with same colour as your table so if you fold them up they function as an extension cushion. The gas piston easily adjusts the angle. They are easily removed with a click-off system.

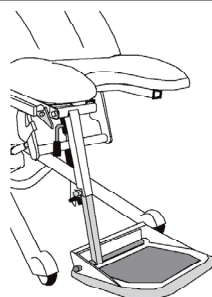

Picture shows right side

6202	6303	6302	6302U
A	A	A	A

525-6336
Leg Rests (pair)

Made of stainless steel, this leg rest has a ball and socket construction allowing tilt of the leg cushion in any direction in addition to the infinite angling when mounted in our leg rest holder model 6338.

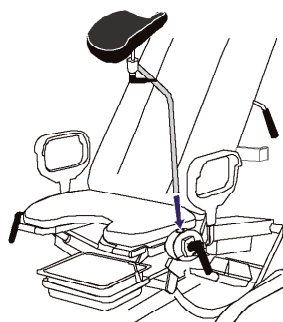

6202	6303	6302	6302U
A	A	A	A

524-6337
Footplates (single)

Made of stainless steel and plastic foot section, fits into our standard leg rest holder.

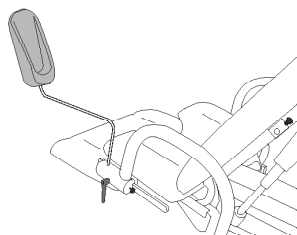

6202	6303	6302	6302U
A	A	A	A

525-6338
Leg Rest Holder (single)

This leg rest holder is standard on all 6300 models. By loosening one handle, you can adjust the leg rest to any height, width or angle. Can be rotated 360 degrees.



6202	6303	6302	6302U
A	A	A	A

524-6339-2 **Discontinued article**

Patient Arm Rest (single)

The Sonesta hand grip/arm rest is designed to be both an arm support and a handgrip, giving the patient many possible places to hold onto. Quickly removed to allow transfer from a wheelchair.

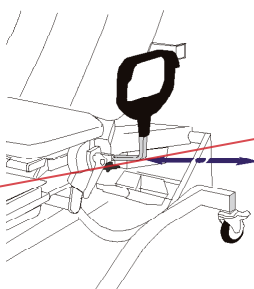

6202	6303	6302	6302U
A	A	A	A

524-6364
Extension Cushion

"Slide-in" extension cushion fits into the 2 square pipes under the front of the seat cushion and is easily removed when patient's legs are put onto the leg rests. Makes the table into a 175 cm long flat examination table.

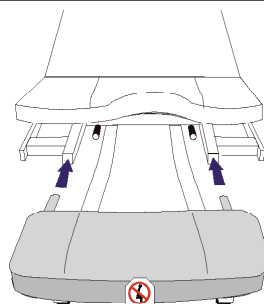

6202	6303	6302	6302U
A	A	A	A

524-6362
Puzzle Piece Extension Cushion

Puzzle piece "Slide-in" extension cushions that fill the standard 170 mm cushion cutout. Fits into the two square pipes under the front of the seat cushion and is easily removed when patient's legs are put onto the leg rests. Makes the table into a long flat examination table.

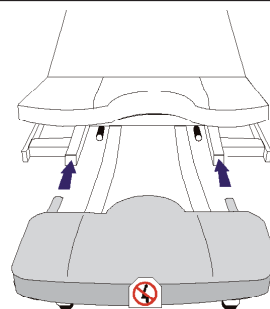

6202	6303	6302	6302U
A	A	A	A

524-6365
Seat Cushion w/o cutout

A 'quick change' accessory seat cushion that can be switched in seconds with any of our other seat cushions. You simply lift up on the front edge and lift it away and replace with another type.

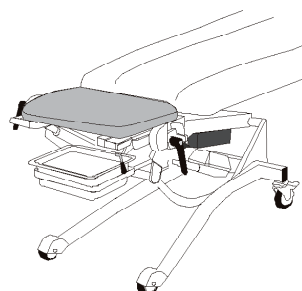

6202	6303	6302	6302U
A	A	A	A

524-6366-1
Seat Cushion 80 mm (pediatric)

80 mm deep cut out. A 'quick change' accessory seat cushion, which can be switched in seconds with any other seat cushion. You simply lift up on the front edge and lift away and replace with another type.

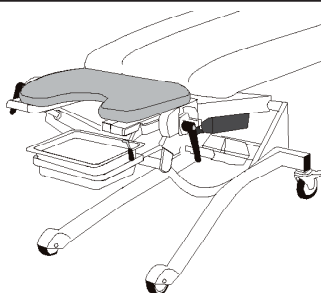

6202	6303	6302	6302U
A	A	A	A

524-6366-2
Seat Cushion 120 mm

120 mm deep cut out. A 'quick change' accessory seat cushion, which can be switched in seconds with any other seat cushion. You simply lift up on the front edge and lift it away and replace with another type.

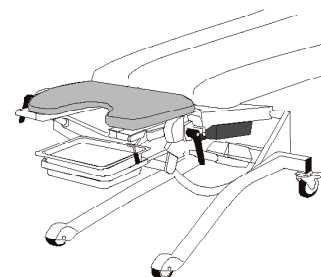

6202	6303	6302	6302U
A	A	A	A

524-6366-3
Seat Cushion w/170 mm cutout

170 mm deep cut out. A 'quick change' accessory seat cushion, which can be switched in seconds with any other seat cushion. You simply lift up on the front edge and lift it away and replace with another type.

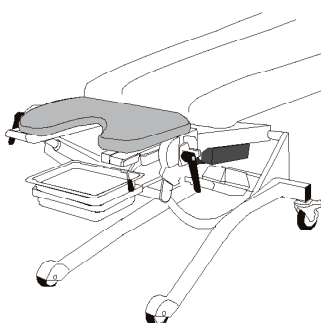

6202	6303	6302	6302U
A	A	A	A

524-6366-4
Seat Cushion 220 mm

220 mm deep cut out. A 'quick change' accessory seat cushion that can be switched in seconds with any other seat cushion. You simply lift up on the front edge and lift it away and replace with another type.

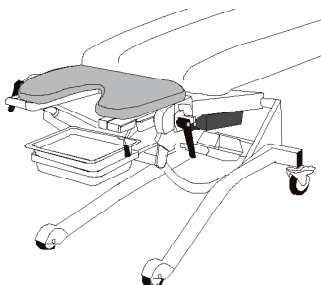

6202	6303	6302	6302U
A	A	A	A

524-6346
Neck Pillow

An adjustable length neck pillow in the same upholstery as your table. A 'Velcro' strip attached to the paper holder allow you to quickly change its position for your patients' height.

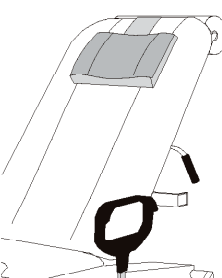

6202	6303	6302	6302U
A	A	A	A

524-P6415
Restraint Strap

Velcro straps for patient fixation. Pair of 1 meter long and 10cm wide straps.

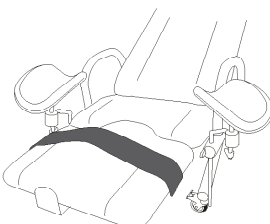

6202	6303	6302	6302U
A	A	A	A

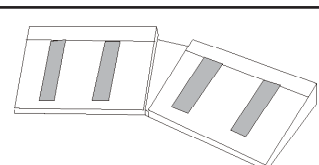
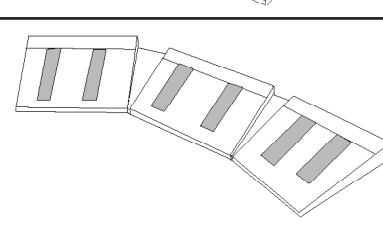
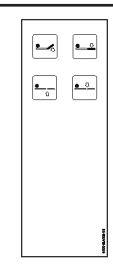
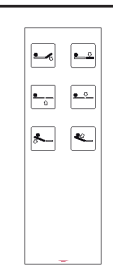
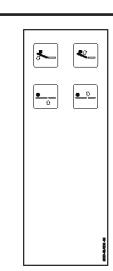
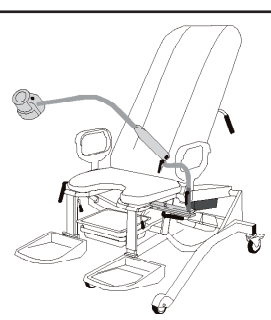
<p>524-6353 Two Motor Foot Control (6302) Waterproof foot control for 2 motor tables with cable to transformer.</p>		6202 -	6303 -	6302 A	6302U A
<p>524-6357 Three Motor Foot Control Waterproof foot control for 3 motor tables with cable to transformer. Two pieces consisting of one 1 single control and one 2 connected controls.</p>		6202 A	6303 A	6302 -	6302U -
<p>524-6354 Two Motor hand control Waterproof hand control for 2 motor tables with cable to transformer. For adjustment of lift and seat motor.</p>		6202 -	6303 -	6302 A	6302U -
<p>524-6355 Three Motor Hand Control Waterproof hand control for 3 motor tables with cable to transformer.</p>		6202 A	6303 A	6302 -	6302U -
<p>524-P6411 Two Motor Hand Control Waterproof hand control for 2 motor tables with cable to transformer. For adjustment of lift and back motor.</p>		6202 -	6303 -	6302 -	6302U A
<p>524-6313 Examination lamp Derungs Licht halogen examination lamp with adjustable holder arm Spot 48 000 lux at 0,5 m Reach 850 mm. With the specially designed arm, this lamp has a 66% switch as well as a full power switch and mounts on either side of table.</p>		6202 A	6303 A	6302 A	6302U A

Cushion Color Samples

A = Accessory

Color #12 (Standard Blue)
Standard colors in Europe/Asia



A

Color #2 (Standard Grey)
Standard colors in USA

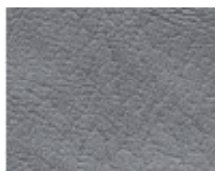

A

Disclaimer:
Due to difference in printers, the colors shown do NOT depict EXACT colors.

Sonesta 6210 Video Fluoroscopy Table



Sonesta Medical offers the following accessories for model Sonesta 6210.

Accessories

S = Standard configuration
A = Accessory

524-6021-6
Arm Rest for 6210

This arm rest is used together with the 524-6329 detachable side rail and 6338-4 arm rest holder. The arm rest is fixed on the right side if facing the table and the arm rest on the left is detachable. The arm rest is covered with a soft foam material.

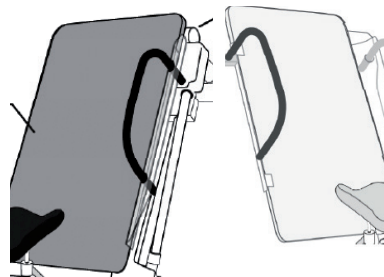

6210

S

524-6338-4
Arm Rest Holder for 6210

This arm rest holder is used together with 524-6021-6 Arm Rest and 524-6329 detachable side rail. By loosening one handle, you can slide the holder up and down the length of the side rail.

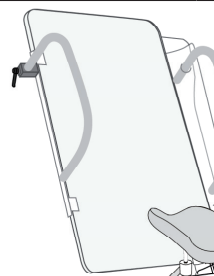

6210

S

524-6325-9
Plastic Funnel w/ Drainage for 6210

A removable plastic funnel (236mm diameter top) mounted on a fixed height 'quick change' holder.

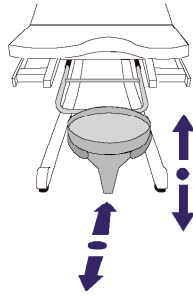

6210
S

525-6331-10
Fold Up Footrests

These footrests are adjustable in length from 30cm - 42cm. They are also adjustable in width and slide outward 19cm each. The bottom is upholstered with same colour as your table so if you fold them up they function as an extension cushion. The gas piston easily adjusts the angle. They are easily removed with a click-off system.

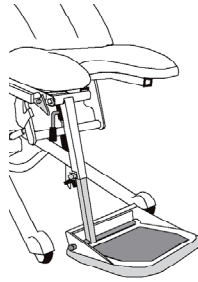

6210
S

525-6336
Leg Rest (pair)

Made of stainless steel, this leg rest has a ball and socket construction allowing tilt of the leg cushion in any direction in addition to the infinite angling when mounted in our leg rest holder model 6338.

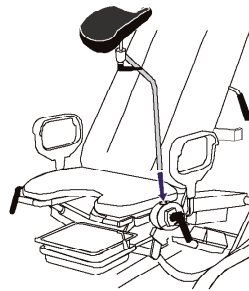

6210
S

524-6337
Footplate (single)

Made of stainless steel and plastic foot section, fits into our standard leg rest holder.

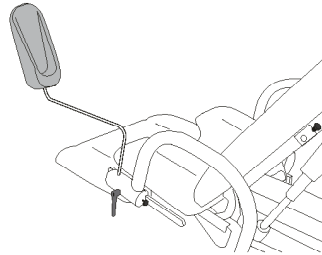

6210
A

525-6338
Leg Rest Holder (single)

This leg rest holder is standard on all 6300 models. By loosening one handle, you can adjust the leg rest to any height, width or angle. Can be rotated 360 degrees.



6210
S

524-P6415
Restraint Strap

Velcro straps for patient fixation. Pair of 1meter long and 10cm wide straps.

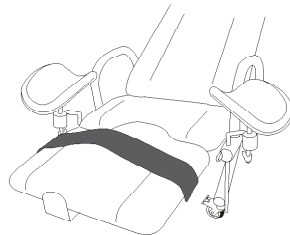

6210
A

524-6356
Hand Control for 6210

Waterproof hand control for 6210 table, with cable to transformer.



6210

S

524-6329
Detachable Side Rail

Fits on the table top's upper rail free part.
Used to attach accessories.

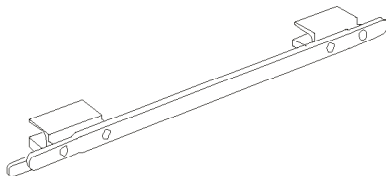

6210

S

An ADDvise Company



SONESTA MEDICAL AB
TEL: +46 8 502 572 80
INFO@SONESTAMEDICAL.SE
ORDER@SONESTAMEDICAL.SE
WWW.SONESTAMEDICAL.SE

SONESTA MEDICAL INC.
TEL: +1 630-519-3450.
INFOUS@SONESTAMEDICAL.SE
ORDERUS@SONESTAMEDICAL.SE
WWW.SONESTAMEDICAL.SE

CM 2019-11-21
VERSION 3

10